



LOW FORWARD VOLTAGE SCHOTTKY BARRIER RECTIFIER

SRL3030P THRU SRL3060P

VOLTAGE RANGE 30 t o 60 Volts
CURRENT 30.0 Amperes

FEATURES

- Schottky Barrier Chip
- Guard Ring Die Construction for Transient Protection
- Low Power Loss, High efficiency
- High Surge Capability
- High Current capacity and Low Forward Voltage Drop
- For use in low voltage high frequency inverters, Free wheeling, and polarity protection applications
- Plastic Material has UL Flammability Classification 94V-0

MECHANICAL DATA

- Case: TO-3P(TO-247AD) molded plastic
- Terminals: Plated Lead solderable per MIL-STD-202 Method 208
- Polarity: See Diagram
- Weight: 5.6 grams (approx)
- Mounting Position: Any
- Marking: Type Number

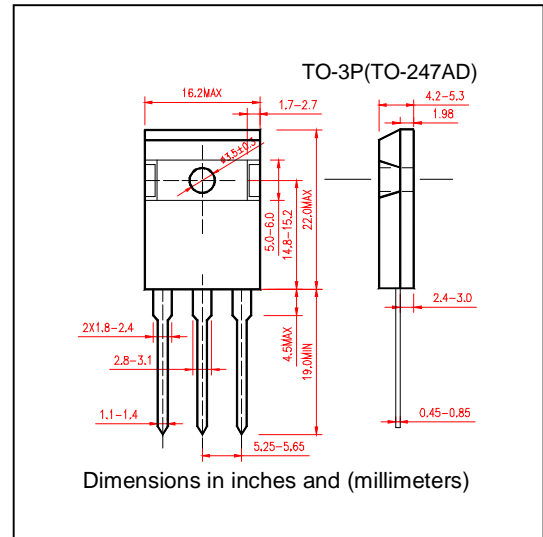

MAXIMUM RATINGS AND ELECTRICAL CHARACTERISTICS

- Single Phase, half wave, 60Hz, resistive or inductive load
- For capacitive load derate current by 20%

	SYMBOLS	SRL 3030P	SRL 3035P	SRL 3040P	SRL 3045P	SRL 3050P	SRL 3060P	UNIT
Peak Repetitive Reverse Voltage	V_{RRM}	30	35	40	45	50	60	V
Working Peak Reverse Voltage	V_{RWM}							
DC Blocking Voltage	V_R							
RMS Reverse Voltage	$V_{R(RMS)}$	21	25	28	32	35	42	V
Average Rectified Output Current (Note 1)@ $T_c=95^\circ C$	I_O	30.0						A
Non-Repetitive Peak Forward Surge Current 8.3ms single half sine wave superimposed on rated load (JEDEC method)	I_{FSM}	275						A
Forward Voltage Drop @ $I_F=15A, T_c=25^\circ C$	V_{FM}	0.55				0.65		V
Peak Reverse Current at Rated DC Blocking Voltage	$T_c = 25^\circ C$	1.0						mA
	$T_c = 100^\circ C$	75						
Typical Junction Capacitance(Note2)	C_j	650						pF
Typical Resistance Junction to case(Note1)	$R_{\theta JC}$	1.5						$^\circ C/W$
Operating and Storage Temperature Range	$T_J T_{STG}$	(-55 to +150)						$^\circ C$

Notes:

1. Thermal Resistance Junction to case mounted on heatsink
2. Measured at 1.0MHz and applied reverse voltage of 4.0V DC



LOW FORWARD VOLTAGE SCHOTTKY BARRIER RECTIFIER

SRL3030P THRU SRL3060P

VOLTAGE RANGE 30 to 60 Volts
CURRENT 30.0 Amperes

RATING AND CHARACTERISTIC CURVES SRL3030P THRU SRL3060P

